

# ADM5120

System on Chip (SoC) Network Controller



The ADM5120 is a high performance, integrated and highly flexible SOC (System-On-Chip) network controller.

Internally, the ADM5120 consists of a high performance (227 MIPS) embedded MIPS CPU, an embedded switch engine, a five port 10/100M PHY, an embedded USB host and interfaces for PCI, UART, SDRAM and Flash. The ADM5120 enables the sharing of IP-based broadband services throughout the home and office using wired and wireless computers, entertainment equipment, printers and other intelligent devices.

It's applications include a SOHO/SME Gateway, NAT Router, USB Print Server and a Single / Multi band WLAN Access Point as well as a range of PCI connected applications. The ADM5120 can be combined with a number of Infineon's other products to add functionality to VoIP and ADSL among other technologies.

## Applications

- Soho and SME Gateways
- NAT Routers
- USB Print Servers
- WLAN Access Points
- Wired and Wireless ATAs

## Features

- 175 MHz/227 MIPS 4Kc CPU with an embedded cache, 8K-byte I-cache and 8K D-cache
- An embedded memory management unit (MMU) 32-entry TLB (Translation Lookaside Buffer), with 16 organized entry pairs
- IEEE 802.3 Fast Ethernet 5 auto-MDIX (auto-crossover) twisted paired LAN interfaces with embedded 10/100M PHY and 1 GMII/MII interface
- PCI, UART, SDRAM and Flash interfaces

- Flexible WAN port selection and embedded switch engine and Data-buffer/Address-look-up table
- Look-up table (read/write-able)
- MAC layer security and MAC clone
- MAC filtering, Bandwidth control and a Class of Services (CoS) with two priority levels
- Shared dynamic data buffer management with embedded SSRAM
- Port grouping VLAN (overlap-able)
- Supports store & forward, modify cut-through, and fast cut-through frame forwarding.

## Software Features

- Linux OS
- IEEE 802.3 Ethernet Driver, IEEE 802.11 WLAN Driver and RS232 Driver for Console User Interface
- DHCP Server/Client, PPP over Ethernet (PPPoE), Network Address Translation (NAT) for IP Address Mapping/Sharing/Security
- DNS Proxy, Simple Network Time Protocol (SNTP) and Firewall

## Physical Characteristics

- CSM CMOS, 0.18 1P5M
- 324-ball BGA package
- 1.8/3.3 V Variable Voltage

[www.infineon.com/products](http://www.infineon.com/products)

Wireline Communications



Never stop thinking.

## ADM5120 Block Diagram

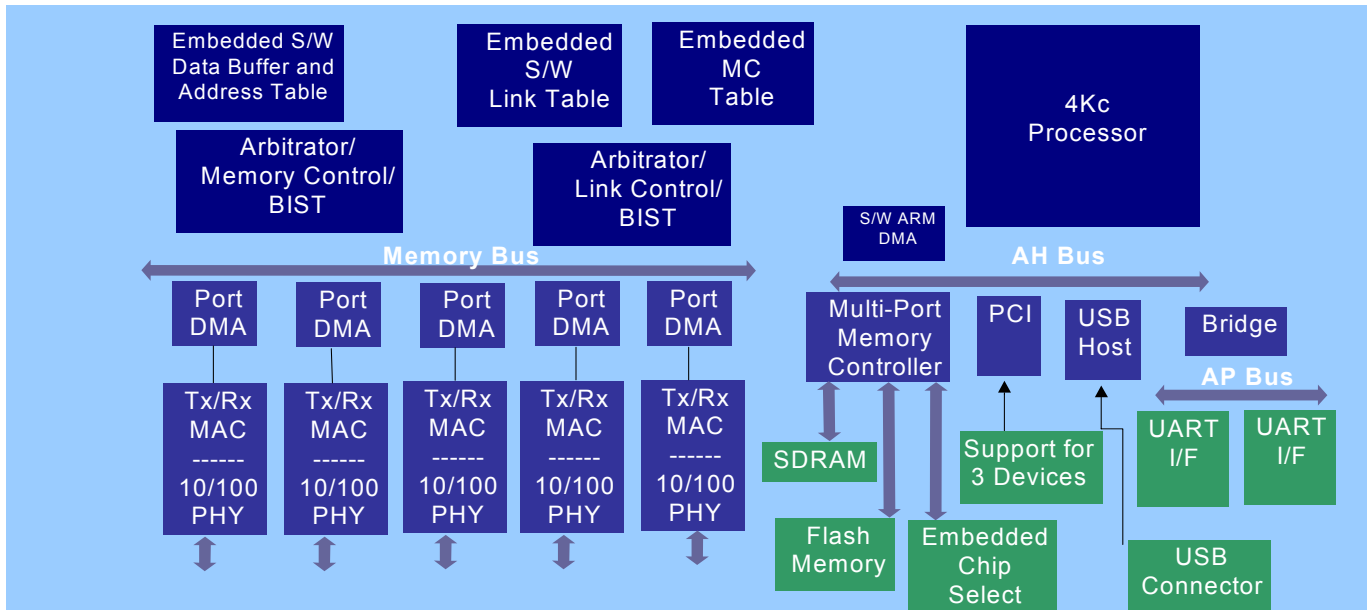

## Product Summary

ADM5120

Product	Sales Code	Description	Package
ADM5120	ADM5120	Network Controller	BGA324

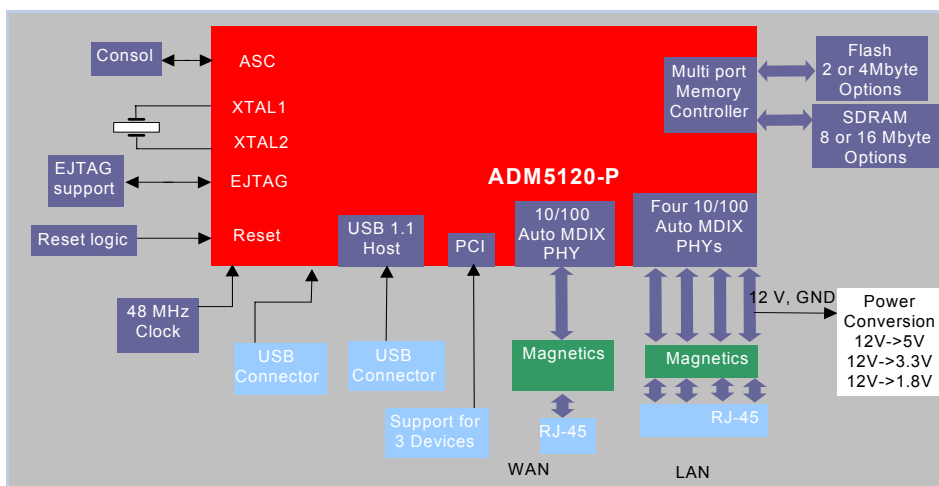

ADM5120

Application Example

How to reach us:

<http://www.infineon.com>

Published by  
Infineon Technologies AG,  
St.-Martin-Strasse 53,  
81669 München

© Infineon Technologies AG 2004.  
All Rights Reserved.

Template: pb\_tmplt\_wide.fm/4  
yb\_rev\_1

### Attention please!

The information herein is given to describe certain components and shall not be considered as a guarantee of characteristics. Terms of delivery and rights to technical change reserved.

We hereby disclaim any and all warranties, including but not limited to warranties of non-infringement, regarding circuits, descriptions and charts stated herein.

### Information

For further information on technology, delivery terms and conditions and prices please contact your nearest Infineon Technologies Office.

### Warnings

Due to technical requirements components may contain dangerous substances. For information on the types in question please contact your nearest Infineon Technologies Office.

Infineon Technologies Components may only be used in life-support devices or systems with the express written approval of Infineon Technologies, if a failure of such components can reasonably be expected to cause the failure of that life-support device or system, or to affect the safety or effectiveness of that device or system. Life support devices or systems are intended to be implanted in the human body, or to support and/or maintain and sustain and/or protect human life. If they fail, it is reasonable to assume that the health of the user or other persons may be endangered.

Ordering No. B000-H0000-X-X-7600  
Printed in Germany  
PS 04043. NB